

NOVA PLUS
ULTRA LOW NO_x
COMBUSTION
SYSTEMS

GAS

2,000,000 -
64,200,000
BTU

Power Flame® Nova Plus™

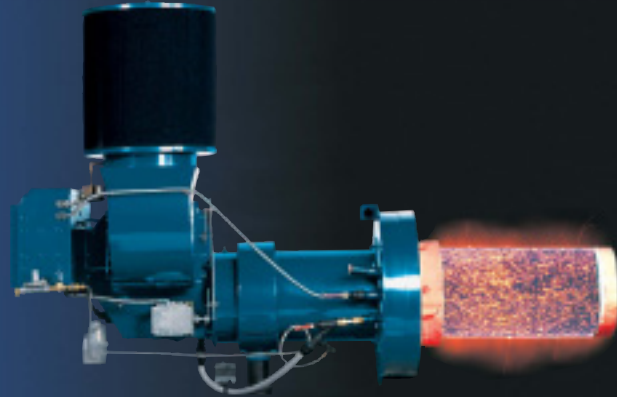

The Power Flame NOVA Plus™ Combustion System employs a patented, fully premixed, surface stabilized combustion technology to provide proven ultra-low NO_x solutions - Sub 7-12 PPM - for commercial, industrial, and process applications. Premixing fuel and air assures complete combustion with minimal levels of CO and unburned hydrocarbons. The all metallic firing head guarantees reliable and consistent performance at the operating conditions necessary to provide single digit NO_x emissions. The NOVA Plus is a simple, cost effective, field proven system designed to meet today's most stringent emissions requirements.

Power Flame provides a U.L.

listed, factory tested package tailored to your job specific requirements. The NOVA Plus is suitable for use on firetube and watertube boiler applications, as well as process heaters. It will operate with uniform heat flux and excellent flame stability over a broad range of operating conditions.

The modular concept that is the basis for all Power Flame burners keeps the initial investment low and maintenance costs at a minimum across the life of the burner. The NOVA Plus is fitted with a state of the art control system and integral panel. The parallel positioning combustion control safely operates the burner and minimizes the start-up time.

Power Flame's Premixed, Surface Stabilized Combustion Burner

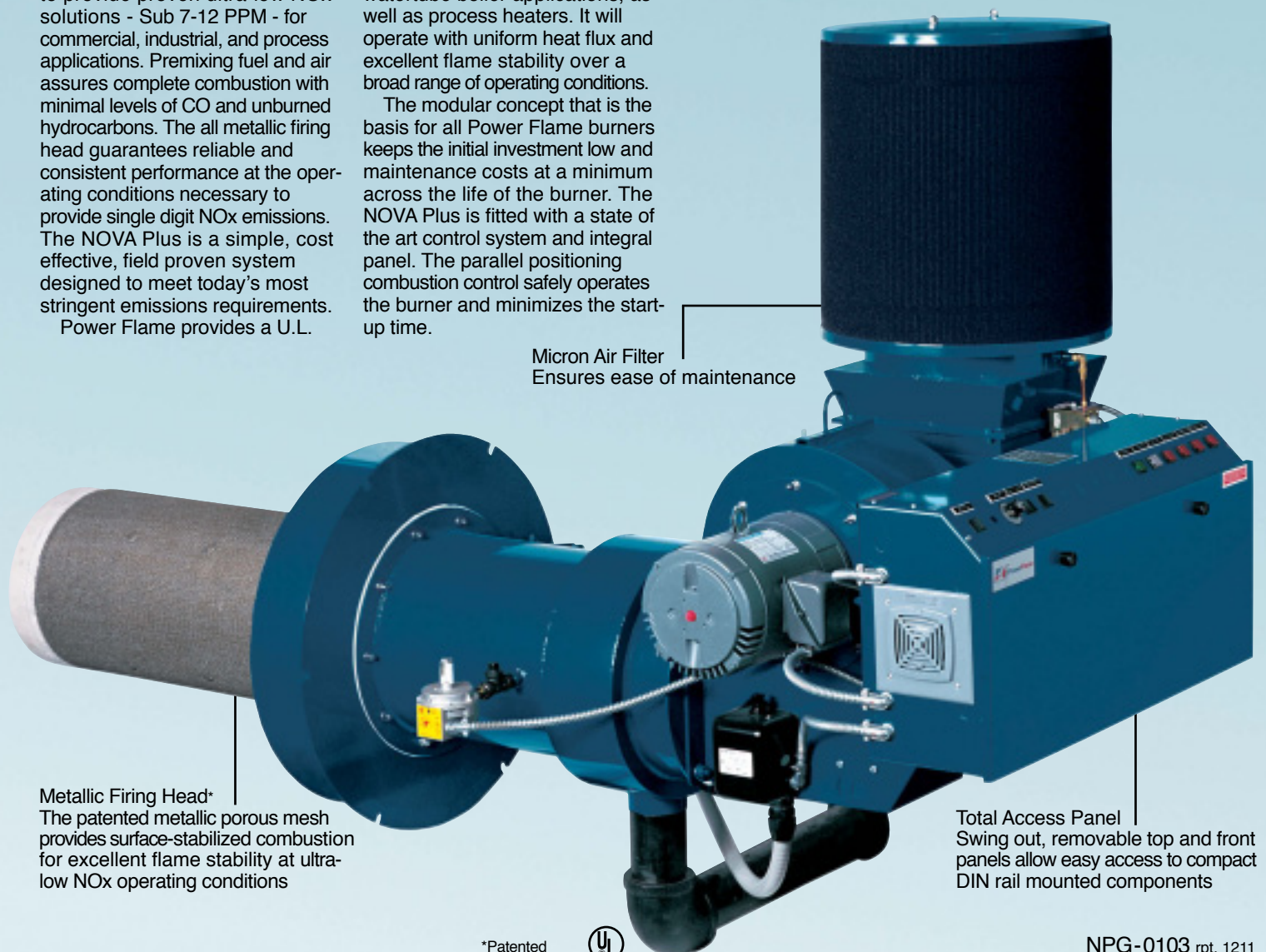

Micron Air Filter
Ensures ease of maintenance

Metallic Firing Head*
The patented metallic porous mesh provides surface-stabilized combustion for excellent flame stability at ultra-low NO_x operating conditions

Total Access Panel
Swing out, removable top and front panels allow easy access to compact DIN rail mounted components

*Patented



NPG-0103 rpt. 1211

Power Flame

The Power to Manage Energy

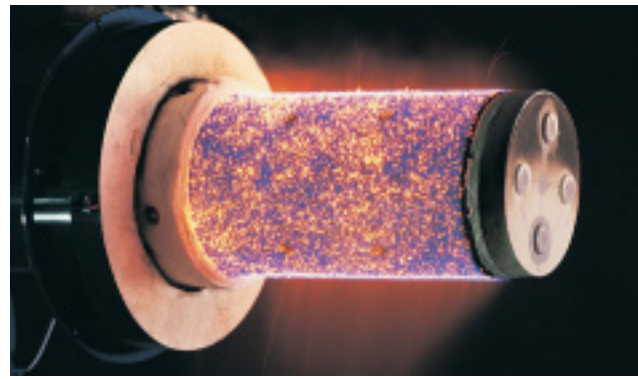

Powered by **ALZETA** CSB Technology

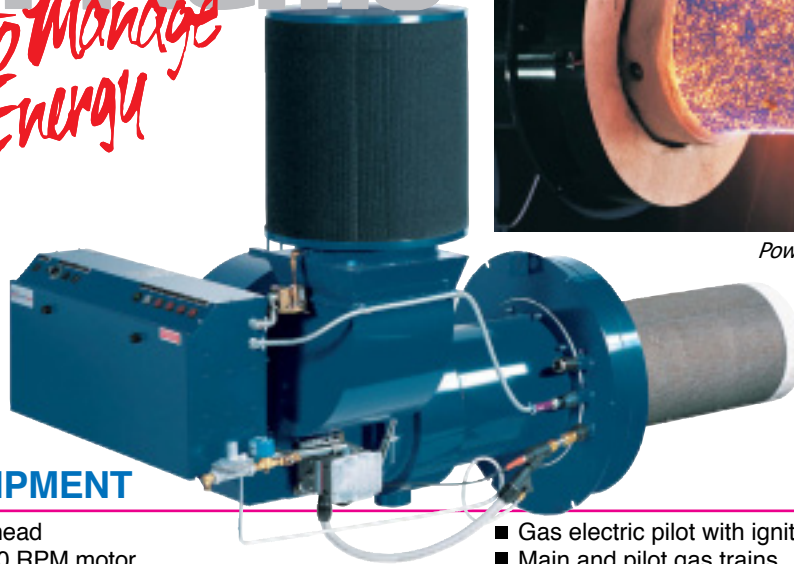

STANDARD EQUIPMENT

- Metallic fiber combustion head
- Blower assembly with 3450 RPM motor
- Venturi mixing chamber
- Combustion control with UV scanner
- Gas electric pilot with ignition transformer
- Main and pilot gas trains
- Linkageless controls (O₂ trim NVC11-NVC17)
- Micron air filter assembly

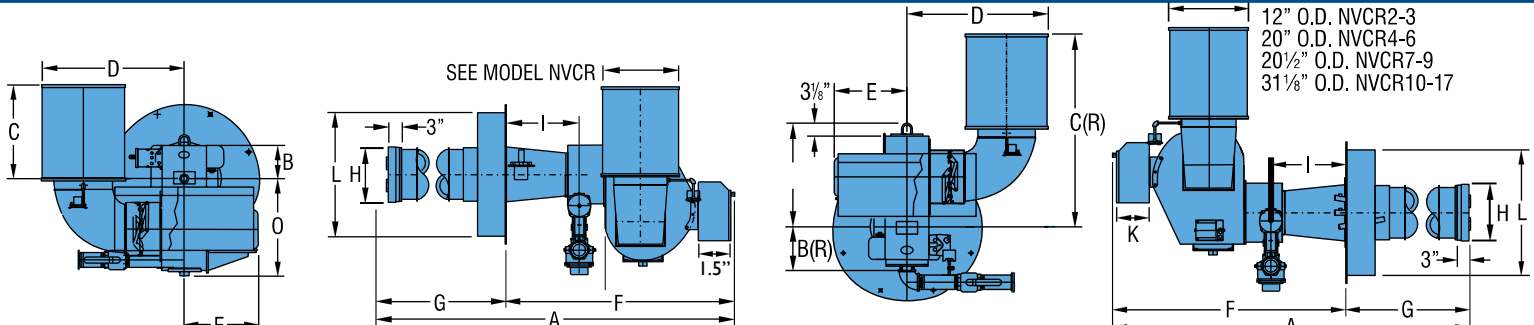

DIMENSIONS

(Inches) Standard Models.

RATINGS & SPECIFICATIONS

Burner Model	A	B	B(R)	C	C(R)	D	E	F	G	H	I	L Min.	O	CAPACITY ¹										
														Blower Motor HP Max.	Standard Gas Train Size (In.)	Nat. Gas MBH Max.	Nominal BHP	Gas Pressure (In. W.C.) ² Min	Furnace Pressure			Nat. Gas MBH Max.	Nominal BHP	Gas Pressure (In. W.C.) ² Min
																			3.0"	6.0"	9.0"			
NVC2-G-20B	69 ³ / ₄	4 ¹ / ₂	6 ¹ / ₄	22 ³ / ₈	34 ³ / ₄	19 ³ / ₈	14	42 ⁷ / ₈	26 ¹³ / ₁₆	7 ¹ / ₄	7 ³ / ₄	17 ¹ / ₂	15 ¹ / ₄	1	1 ¹ / ₂	2,000	47.6	18	1,600	38	16	NA	NA	NA
NVC3-G-20	76 ⁷ / ₈	5 ¹ / ₄	7	21 ³ / ₈	35 ⁵ / ₈	20	16	45 ¹ / ₈	31 ²³ / ₃₂	7 ¹ / ₄	7 ³ / ₄	17 ¹ / ₂	17	1 ¹ / ₂	2	2,500	59.5	18	2,000	48	16	NA	NA	NA
NVC3-G-25A	81 ⁷ / ₈	5 ¹ / ₄	7	21 ³ / ₈	35 ⁵ / ₈	20	16	45 ¹ / ₈	37	7 ¹ / ₄	7 ³ / ₄	17 ¹ / ₂	17	3	2	3,000	71.4	18	2,400	57	16	NA	NA	NA
NVC3-G-25B	86 ⁷ / ₈	5 ¹ / ₄	7	21 ³ / ₈	35 ⁵ / ₈	20	16	45 ¹ / ₈	41 ¹³ / ₁₆	7 ¹ / ₄	7 ³ / ₄	17 ¹ / ₂	17	3	2	3,500	83.3	18	2,800	67	16	NA	NA	NA
NVC4-G-30	92 ² / ₁₆	6 ¹ / ₄	7 ⁵ / ₁₆	28	38 ⁵ / ₈	32 ¹ / ₂	18 ¹ / ₂	60 ¹ / ₂	31 ²³ / ₃₂	14 ¹ / ₂	20 ¹ / ₄	23 ⁵ / ₁₆	18 ³ / ₄	5	2 ¹ / ₂	5,000	119	21	4,000	95	18	NA	NA	NA
NVC5-G-30A	97 ¹ / ₈	6 ¹ / ₄	7 ⁵ / ₁₆	28	38 ⁵ / ₈	32 ¹ / ₂	18 ¹ / ₂	60 ¹ / ₂	36 ³ / ₈	14 ¹ / ₂	20 ¹ / ₄	23 ⁵ / ₁₆	18 ³ / ₄	7 ¹ / ₂	2 ¹ / ₂	6,000	142.9	21	4,800	114	18	NA	NA	NA
NVC5-G-30	102 ¹ / ₁₆	6 ¹ / ₄	7 ⁵ / ₁₆	28	38 ⁵ / ₈	32 ¹ / ₂	18 ¹ / ₂	60 ¹ / ₂	41 ⁵ / ₈	14 ¹ / ₂	20 ¹ / ₄	23 ⁵ / ₁₆	18 ³ / ₄	7 ¹ / ₂	2 ¹ / ₂	7,000	166.6	21	5,600	133	18	NA	NA	NA
NVC6-G-30A	102 ¹ / ₁₆	6 ¹ / ₄	7 ⁵ / ₁₆	28	38 ⁵ / ₈	32 ¹ / ₂	18 ¹ / ₂	60 ¹ / ₂	41 ⁵ / ₈	14 ¹ / ₂	20 ¹ / ₄	23 ⁵ / ₁₆	18 ³ / ₄	10	2 ¹ / ₂	8,400	200	21	6,720	160	18	NA	NA	NA
NVC6-G-30	111 ⁵ / ₁₆	6 ¹ / ₄	7 ⁵ / ₁₆	28	38 ⁵ / ₈	32 ¹ / ₂	20	60 ¹ / ₂	51 ¹³ / ₃₂	14 ¹ / ₂	20 ¹ / ₄	23 ⁵ / ₁₆	18 ³ / ₄	10	3	10,500	250	28	8,400	200	22	NA	NA	NA
NVC7-G-30	115 ⁵ / ₁₆	8 ¹ / ₁₆	9 ⁹ / ₁₆	24 ¹ / ₈	48 ³ / ₄	34 ⁷ / ₈	20	64 ¹ / ₈	51 ¹³ / ₃₂	14 ¹ / ₂	19 ¹ / ₄	23 ⁵ / ₁₆	23 ⁷ / ₈	15	3	12,600	300	28	10,080	240	22	7,000	167	20
NVC8-G-30	122 ¹ / ₂	8 ¹ / ₁₆	9 ⁹ / ₁₆	23 ¹ / ₄	49 ¹ / ₂	34 ⁷ / ₈	20	70 ⁵ / ₈	51 ¹³ / ₃₂	14 ¹ / ₂	19 ¹ / ₄	23 ⁵ / ₁₆	28 ⁷ / ₈	15	3	14,700	350	28	11,760	280	22	7,200	171	20
NVC9-G-30	124 ⁷ / ₈	6 ³ / ₈	8 ⁵ / ₁₆	25 ¹ / ₂	38 ⁵ / ₈	35 ¹ / ₈	21 ¹ / ₂	79 ³ / ₄	46	22 ⁵ / ₈	27 ⁵ / ₈	31	29 ⁷ / ₈	15	3	16,800	400	56	13,440	320	40	9,200	219	36
NVC10-G-30A	128 ³ / ₈	7 ³ / ₄	9 ¹ / ₁₆	26	41 ³ / ₈	45 ³ / ₄	27	83 ¹ / ₄	46	22 ⁵ / ₈	26 ¹ / ₈	31	34 ³ / ₄	20	3	20,500	488	56	16,400	390	40	11,800	281	36
NVC10-G-30	128 ³ / ₈	7 ³ / ₄	9 ¹ / ₁₆	26	41 ³ / ₈	45 ³ / ₄	27	83 ¹ / ₄	46	22 ⁵ / ₈	26 ¹ / ₈	31	34 ³ / ₄	20	3	21,840	500	56	21,000	500	56	15,120	360	56
NVC11-G-30	140 ⁵ / ₈	8 ³ / ₄	10 ³ / ₄	25 ¹ / ₂	42 ³ / ₈	46 ¹ / ₂	27 ³ / ₄	80 ¹ / ₂	61	22 ⁵ / ₈	19 ⁵ / ₈	31	38 ¹ / ₄	30	3	26,200	600	140	25,200	600	140	18,100	431	140
NVC12-G-30	142 ⁹ / ₁₆	8 ³ / ₄	10 ³ / ₄	25 ¹ / ₂	59 ¹ / ₂	46 ³ / ₄	27 ³ / ₄	81 ⁹ / ₁₆	61	22 ⁵ / ₈	19 ⁵ / ₈	31	38 ¹ / ₄	30	3	30,500	700	140	29,400	700	140	25,290	602	140
NVC13-G-30	157 ¹ / ₂	8 ³ / ₄	10 ³ / ₄	49 ¹ / ₄	66 ¹ / ₈	46 ³ / ₄	27 ³ / ₄	81 ⁹ / ₁₆	75 ¹⁵ / ₁₆	22 ⁵ / ₈	19 ¹ / ₄	31	38 ¹ / ₄	40	3	36,500	810	140	36,114	860	140	32,800	781	140
NVC14-G-30	151 ⁷ / ₈	8 ³ / ₄	10 ³ / ₄	51 ⁷ / ₈	68 ³ / ₄	47 ⁷ / ₈	27 ³ / ₄	96 ¹ / ₈	55 ³ / ₄	29	32 ³ / ₁₆	43 ¹ / ₂	38 ¹ / ₄	40	3	39,500	905	140	39,000	929	140	36,480	869	140
NVC15-G-30	167 ¹ / ₂	8 ³ / ₄	10 ³ / ₄	51 ⁷ / ₈	68 ³ / ₄	47 ⁷ / ₈	27 ³ / ₄	96 ¹ / ₈	71 ³ / ₈	29	32 ³ / ₁₆	43 ¹ / ₂	38 ¹ / ₄	50	3	45,000	1,050	140	44,500	1,060	140	42,240	1,006	140
NVC16-G-30	177 ⁵ / ₈	10	13	49 ⁵ / ₈	82 ¹³ / ₁₆	48 ¹ / ₈	26 ¹³ / ₁₆	97 ¹⁵ / ₁₆	79 ²³ / ₃₂	29	31 ¹³ / ₁₆	43 ¹ / ₂	38 ⁷ / ₈	60	3	53,000	1,215	140	52,000	1,238	140	50,750	1,208	140
NVC17-G-40	207 ³ / ₈	11 ¹ / ₈	14 ¹ / ₈	47 ³ / ₄	84 ⁹ / ₁₆	49 ¹ / ₄	37 ⁷ / ₈	102 ¹ / ₄	105 ⁵ / ₃₂	29	31 ¹³ / ₁₆	43 ¹ / ₂	43	100	4	64,400	1,530	140	64,300	1,531	140	64,200	1,529	140



Power Flame Incorporated

2001 South 21st Street Phone 620-421-0480
Parsons, KS 67357 Fax 620-421-0948

Web Site: <http://www.powerflame.com>

E-Mail: csd@powerflame.com

1. Capacities listed are based upon the furnace pressures noted. Derate capacities approximately 5% for each + 0.50" W.C. combustion chamber pressure. Consult factory for additional capacity information.
2. At inlet to main manual shutoff cock to obtain P/F certified ratings with standard U.L. gas train. Optional gas trains available for lower pressures.

© Copyright Power Flame Incorporated 2010 Printed in U.S.A.

Power Flame® Nova Plus 2™



The Power of Choice **Power Flame's Premixed, Surface Stabilized Combustion Burner**

The Power Flame NOVA Plus 2™ Combustion System employs a fully premixed, surface stabilized combustion technology to provide proven ultra-low NOx solutions – **Sub 9 to 20 PPM** – without FGR for commercial, industrial and process applications.

Premixing fuel and air assures complete combustion with minimal levels of CO and unburned hydro-carbons.

The all metallic firing head

guarantees reliable and consistent performance at the operating conditions necessary to provide single digit NOx emissions.

The NOVA Plus 2 is a simple, cost effective, field proven system designed to meet today's most stringent emissions requirements.

Power Flame provides a U.L. listed, factory tested

package, tailored to your job specific requirements. The NOVA Plus 2 is suitable for use on firetube and watertube boiler applications, as well as process heaters. It will operate with uniform heat flux and excellent flame stability over a broad range of operating conditions.

The modular concept that is the basis for all Power

Flame burners keeps the initial investment low and maintenance costs at a minimum across the life of the burner.

The NOVA Plus 2 is equipped with a state of the art control system and integral panel. The parallel positioning combustion control safely operates the burner and minimizes the start-up time.

Linkageless Controls

Total Access Panel

Swings out, easily removable top and front panels give total access to circuit board mounted operating controls

Metallic Firing Head

The metallic porous mesh provides surface-stabilized combustion for excellent flame stability at ultra-low NOx operating conditions

Washable Stainless Steel Filter Assembly



Power Flame

The Power to Manage Energy

STANDARD EQUIPMENT

- Metallic fiber combustion head
- Blower assembly with 3450 RPM motor
- Variable frequency drive (optional)
- Combustion control with UV scanner
- Gas electric pilot with ignition transformer
- Main and pilot gas trains
- Linkageless controls
- Washable stainless steel filter assembly

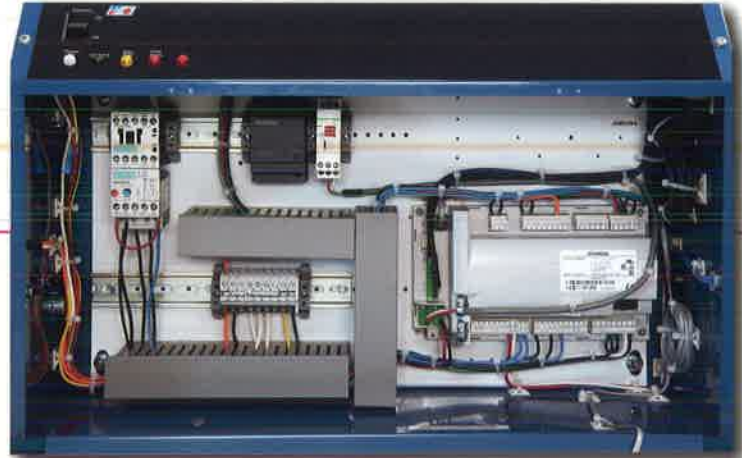

Nova Plus 2 is furnished with the exclusive Alpha System LED display. Modulating control is achieved through the use of linkageless controls mounted in the control panel.

MODEL NP2

MODEL NP2R

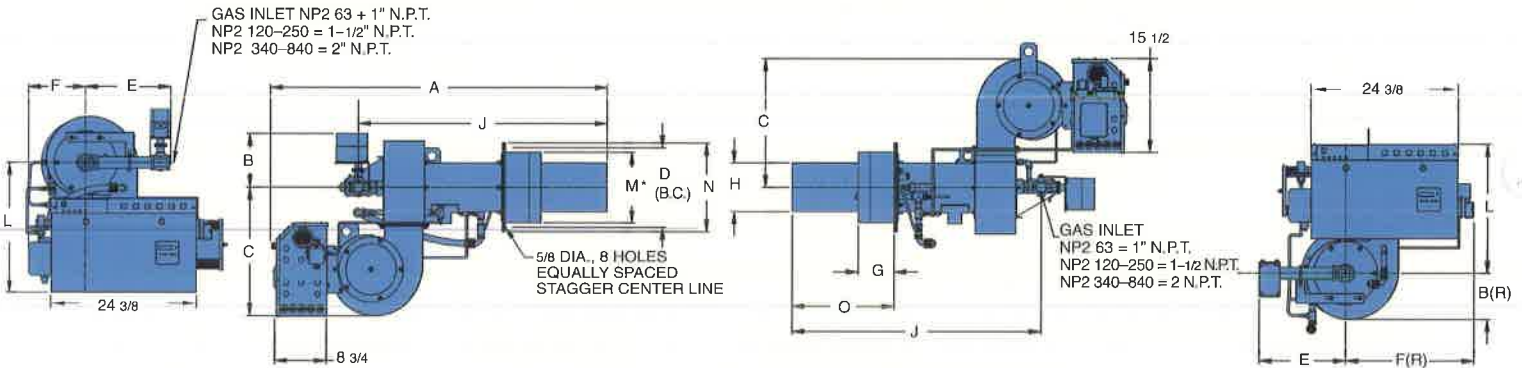

* ADD 3/8" TO "M" FOR OPENING IN HEAT EXCHANGER FRONT PLATE

DIMENSIONS (Inches) Standard Models

RATINGS & SPECIFICATIONS

Burner Model	A	B	B(R)	C	D(B.C.)	E	F	F(R)	G	H	J	L	M	N	O	CAPACITY ¹							
																BLOWER MOTOR H.P. MAX.	STD. GAS TRAIN SIZE	NAT. GAS MBH MAX.	NOMINAL BOILER BHP	GAS PRESS (IN. W.C.) ² MIN.	NAT. GAS MBH MAX.	NOMINAL BOILER BHP	GAS PRESS. (IN. W.C.) ² MIN.
NP2-G-63	48 3/8	10 7/8	6 1/2	16 5/8	11 1/8	13 7/8	11	19 7/8	4	5 3/4	33 1/4	19 1/2	9 5/8	12 5/8	10 1/4	1 1/2	1"	700	16.7	7.7	750	17.9	8.3
NP2-G-120	53 3/8	10 7/8	6 1/2	16 5/8	11 1/8	13 7/8	11	19 7/8	4	5 3/4	38 1/4	19 1/2	9 5/8	12 5/8	15 1/4	3/4	1 1/2"	1,230	29.3	8.4	1,360	32.4	9.7
NP2-G-170	56 3/8	10 7/8	7 3/4	21 1/4	13 1/8	14 1/4	9 1/2	21 1/4	6	8 1/8	41 1/4	21 1/2	11 5/8	14 5/8	17 1/4	1.0	1 1/2"	1,740	41.4	11.4	1,900	45.2	12.7
NP2-G-250	62 3/8	10 7/8	7 3/4	21 1/4	13 1/8	14 3/8	9 1/2	21 1/4	6	8 1/8	47 5/8	21 1/2	11 5/8	14 5/8	23 1/4	2.0	1 1/2"	1,998	47.5	12.5	2,770	66.0	13.7
NP2-G-340	66 3/8	10 7/8	7 3/4	21 1/4	13 1/8	14 3/8	9 1/2	21 1/4	6	8 1/8	51 5/8	21 1/2	11 5/8	14 5/8	27 1/4	2.0	2"	3,200	76.2	13.1	3,470	82.6	14.1
NP2-G-420	67	10 7/8	7 3/4	21 1/4	15 1/8	14 3/8	9 3/4	21	6	9 7/8	53 7/8	21 1/2	13 5/8	16 5/8	28 1/4	3.0	2"	4,375	104.2	14.4	5,020	119.5	15.8
NP2-G-520	74 7/8	11 1/2	7 3/4	23 3/4	15 1/8	14 1/2	9 3/4	21	6	9 7/8	59	24 1/8	13 5/8	16 5/8	33 1/4	5.0	2"	4,998	119.0	20.0	6,100	145.2	21.4
NP2-G-630	86	11 1/2	11 1/8	29	21 1/2	14 1/4	11 3/4	40 1/8	8 1/2	12	60 3/8	29 7/8	20	23	33 7/8	7.5	2"	6,300	150.0	16.0	7,350	175.0	18.0
NP2-G-840	94	11 1/2	11 1/8	29	21 1/2	14 1/4	11 3/4	40 1/8	8 1/2	12	68 3/8	29 7/8	20	23	41 7/8	10.0	2"	8,400	200.0	32.0	8,600	209.7	32.5



Power Flame Incorporated

2001 South 21st Street Phone 620-421-0480
Parsons, KS 67357 Fax 620-421-0948
Web Site: <http://www.powerflame.com>
E-Mail: csd@powerflame.com

- Note 1. Capacities listed are based on +1.0" W.C. positive pressure. Refer to capacity curves for derates based upon combustion chamber pressure.
2. At inlet to main manual shutoff cock to obtain P/F certified ratings with standard U.L. gas train. Optional gas trains available for lower pressures.
3. Maximum Gas Pressure 56 in w.c.

Consult Factory for dimension verification prior to construction